

Meta Brass

assembly and mounting instructions

Notes before assembly



We recommend reading the complete assembly manual before starting the installation.

Disconnect the power by turning off the circuit breaker, or by removing the fuse in the fuse box before assembling and mounting.

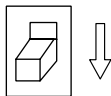

Use gloves provided at any time of the installation



Two people are needed for installation.

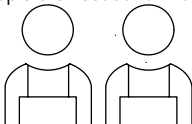

Be careful when unpacking the product to avoid damaging any of the elements. We recommend placing it on a protective surface such as a cardboard or a blanket.

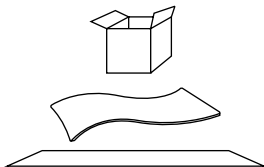

Notas antes del montaje



Recomendamos leer el manual de montaje completo antes de iniciar la instalación.

Desconecte la alimentación bajando la pastilla o quitando el fusible de la caja de fusibles antes de ensamblar y montar.

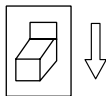

Utilice los guantes proporcionados en cualquier momento de la instalación.



Se necesitan dos personas para la instalación.

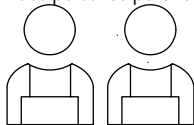

Tenga cuidado al desempacar este producto para no dañar ninguno de los elementos. Recomendamos colocarlo sobre una superficie protectora como un cartón o una manta y el uso de un par de guantes(incluidos)

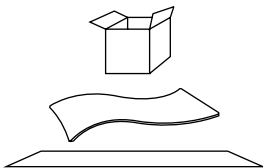

Material care

Recinto or fiorito - Use a soft rag, a clean white cloth, or vacuum with a soft brush attachment as needed, do not wipe wet.

Powder coated Aluminum - Dust gently with a duster or soft rag. Do not use commercial cleaners.
Avoid abrasive cleaning agents.

Polished brass - The hand polished solid brass will naturally oxidate and reflect the language of time. Upon touching the items without gloves, fingerprints are likely to occur and leave marks. Use a good quality brass cleaning liquid in order to remove any marks from the brass. Please note that you will also lose the age brass look. Do not apply pressure to avoid any scratches.

Cuidado del material

Recinto o fiorito - Use un trapo suave, un paño blanco limpio o aspire con un accesorio de cepillo suave según sea necesario, no lo limpie en húmedo.

Metal - Retire el polvo suavemente con un plumero o un trapo suave y seco. No utilice limpiadores comerciales. Evite los agentes de limpieza abrasivos.

Latón - El latón sólido pulido, comenzará a tener un lenguaje propio a través del envejecimiento que tendrá.
Por lo que recomendamos usar guantes para evitar marcas no deseadas. Para remover manchas, use un limpiador líquido de metales específicos para latón o plata. Aplíquelo a una microfibrá y frote suavemente

Parts included



Canopy 55x15cm

Partes incluidas

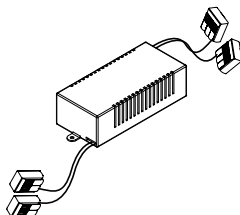

Driver and connectors

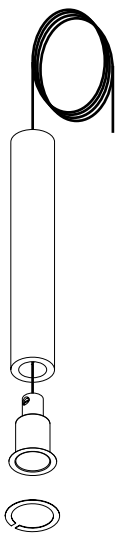

Stone + Technic



Screws and dowels

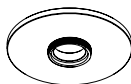

Brass Disc



COB LED Bulb



Brass Bulb Cover

1

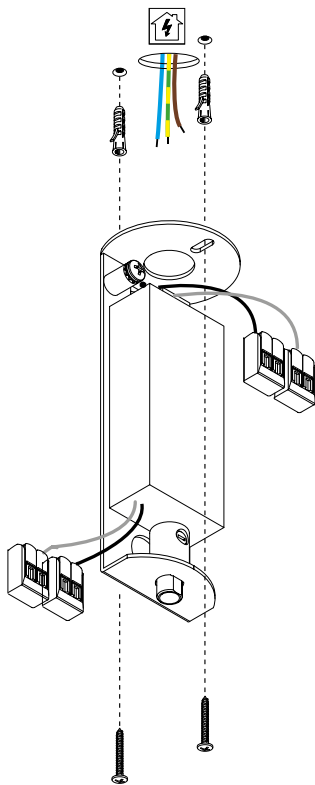

2

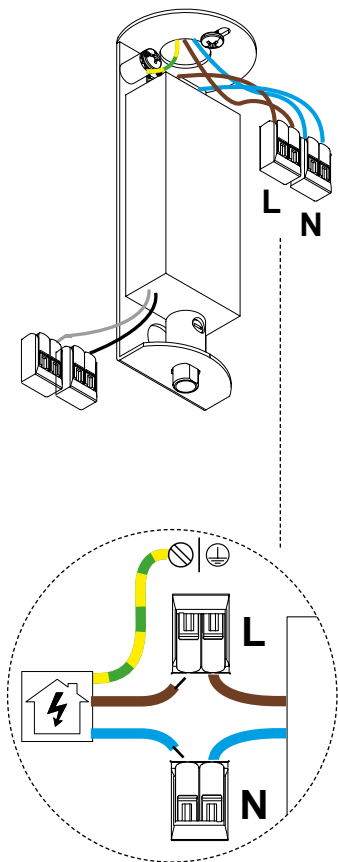

3

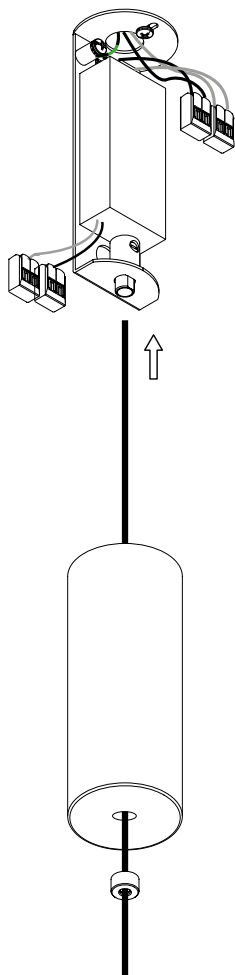

4

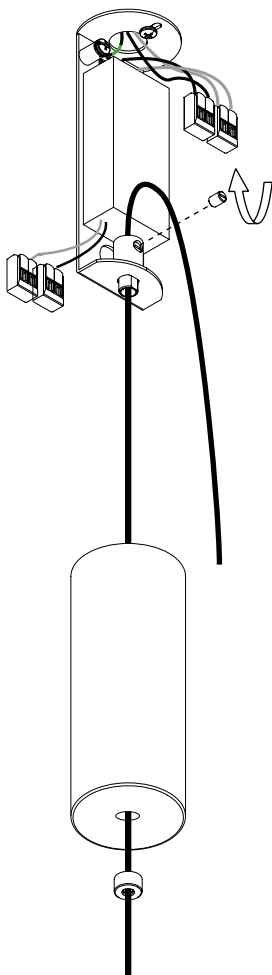

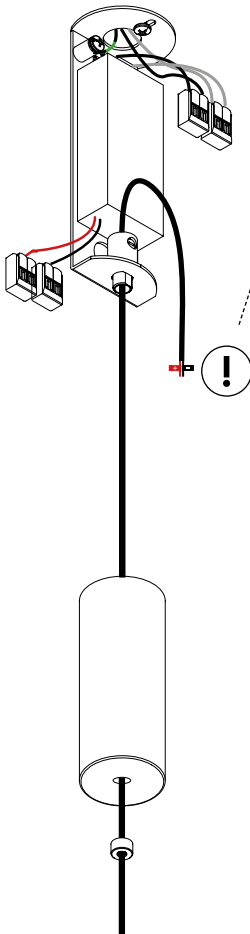

1

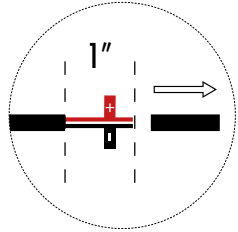

2

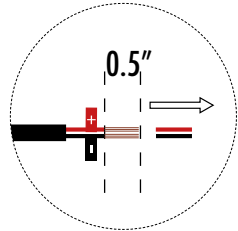

3

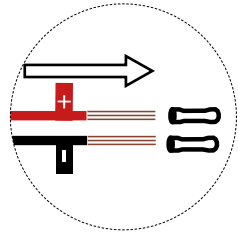

4

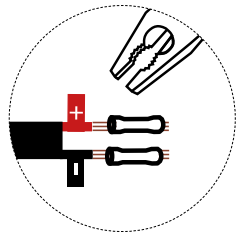

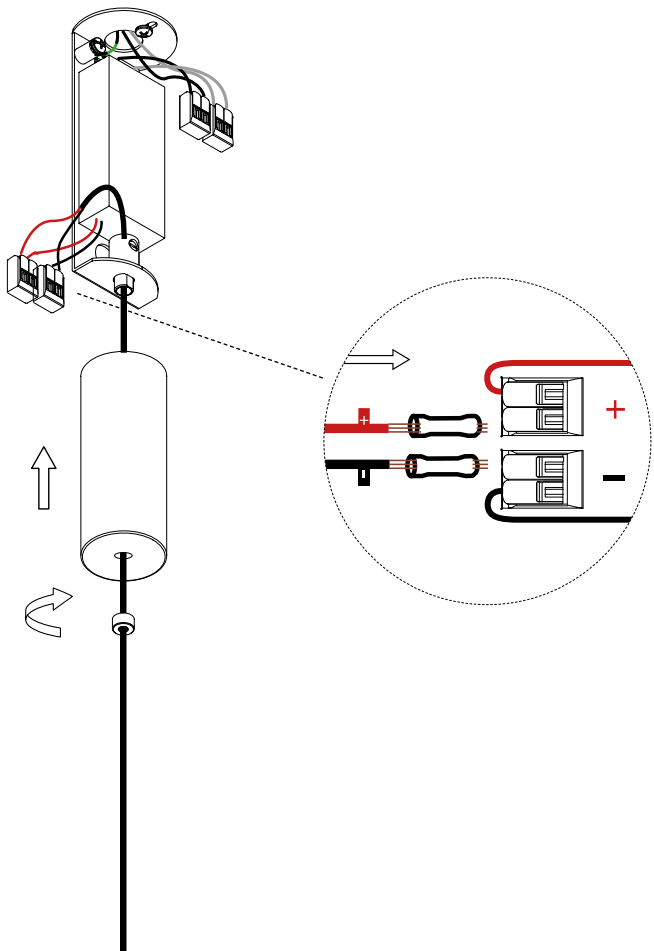

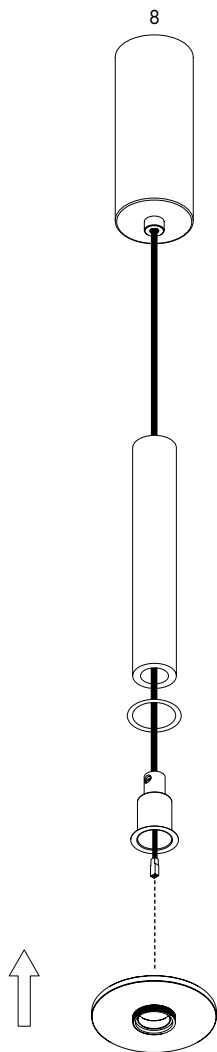
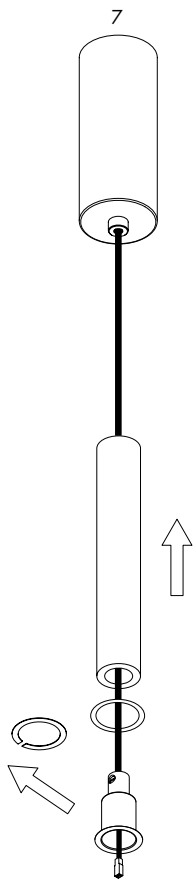

9

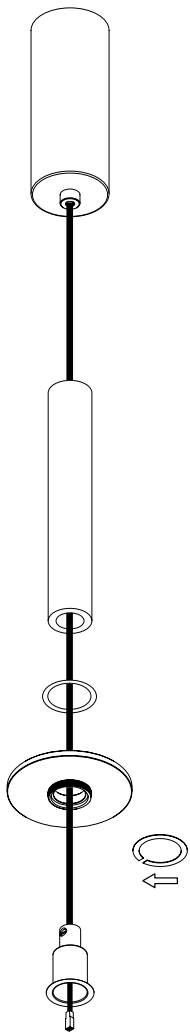

10

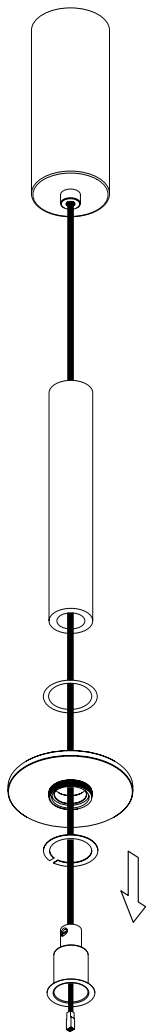

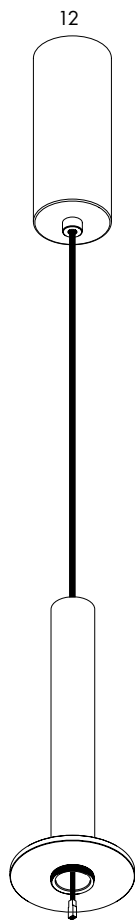
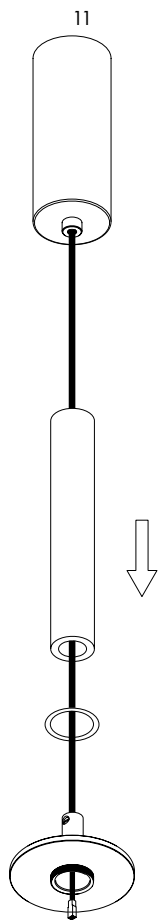

13

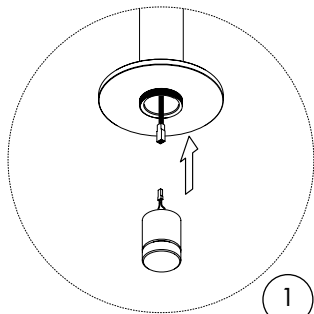
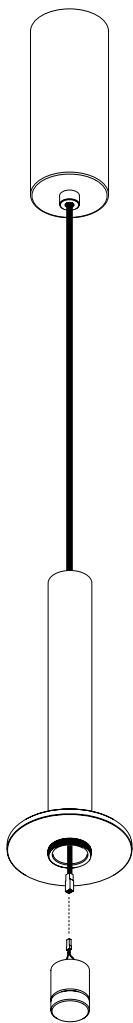

1

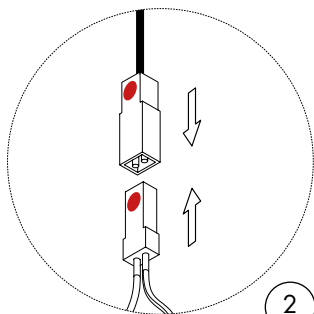

2

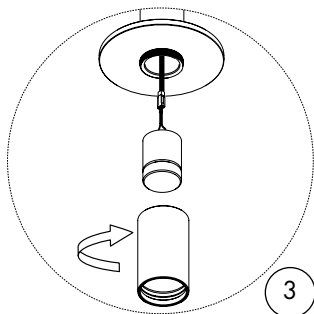

3

